

polytec

PARTITIONING SYSTEMS

polytec

www.polytec.com.au

p 1300 300 547

ISSUE: 01h



polytec offer an express sample service.

Visit www.polytec.com.au to order your free sample.

Create your look

PROUDLY
SUPPORTING



Find your local supporting cabinet maker
www.polytec.com.au/mcgrath-foundation

Partitions in 13mm **COMPACT** laminate Prime Oak Woodmatt.
Hardware in Black Matt.



PARTITIONING SYSTEMS

polytec Partitioning Systems provide a durable and robust Compact laminate toilet and shower partition system. Offering a range of over 40 colours this custom-made flat packed system includes bench seating, modesty panels, dividers and drop front benchtops alongside the eight combinations of our four system styles to transform your wet area.

As the consummate, long-lasting, low-maintenance decorative panel, **polytec's** Compact laminate is a go-to product for the most demanding professional interior joinery environments.

Being manufactured from quality materials embeds **polytec's** Compact laminate with excellent technical characteristics. It's totally impervious to water and has outstanding impact, stain and wear resistance, along with excellent hygienic properties.

Characterised by a distinctive black core, Compact laminate holds extra appeal on the aesthetic front and as a structurally sound material.

The introduction of Smooth and Woodmatt finishes into **polytec's** Compact laminate range avails exciting new design possibilities for commercial projects. **polytec's** Smooth finish is a sleek, flat surface with minimal reflectance available in a range of stone patterns. **polytec's** ever-popular Woodmatt finish has been introduced to the range, allowing for greater design flexibility with a realistic woodgrain feel in timber designs.

polytec's Smooth and Matt finish boasts antibacterial properties due to the flat surface.

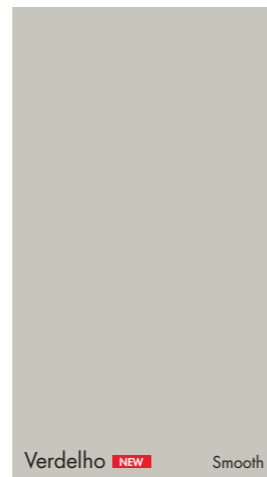
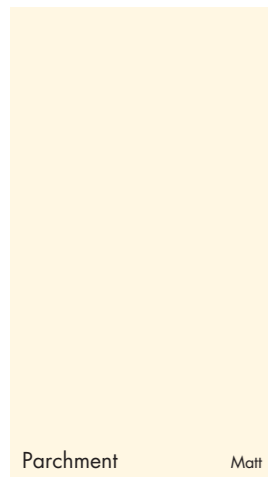
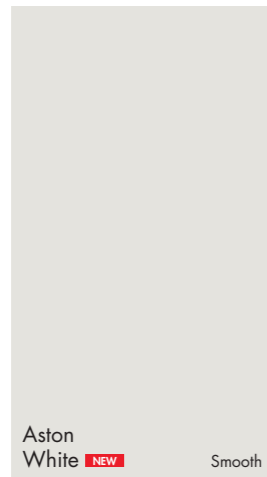
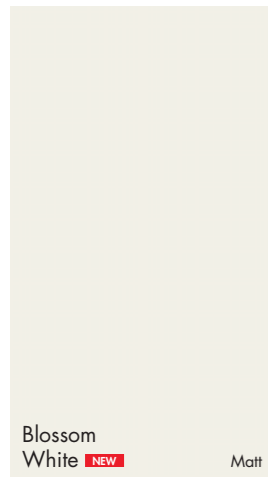
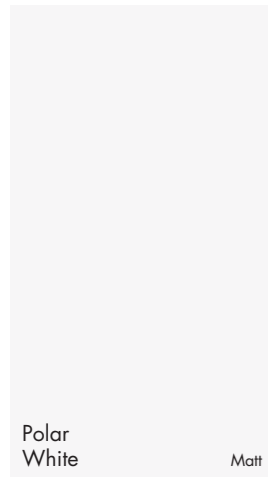

Café tops in COMPACT laminate Calacutta Grey Smooth.

Available edge profiles

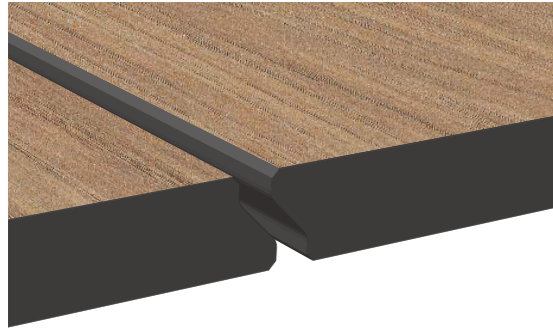

Modesty Edge

Modesty Edge creates an overlapped joint to ensure ultimate privacy when doors are closed.



Aris

All partitioning doors are supplied with Aris Edge unless Modesty Edge is specified.

Partitions in 13mm COMPACT laminate Prime Oak Woodmatt. Hardware in Black Matt. t

COMPACT laminate

polytec swatches and samples represent a small area of the overall colour structure. To view the large colour sample, visit www.polytec.com.au.

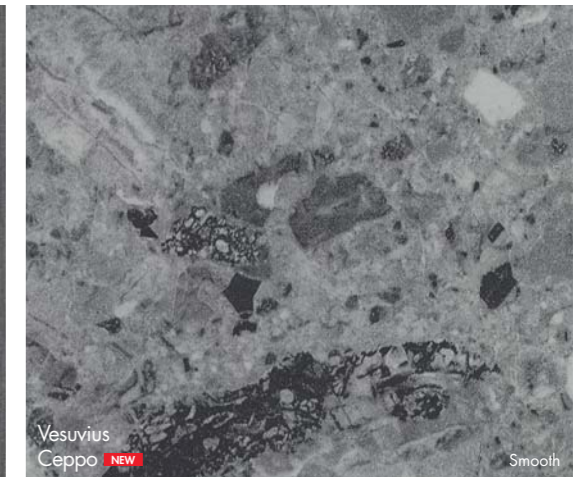
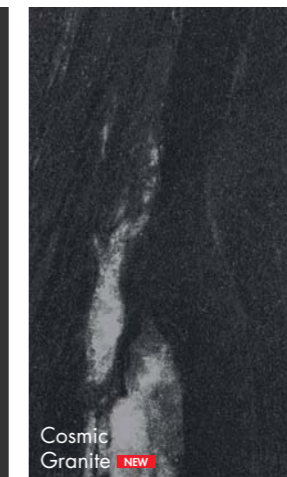
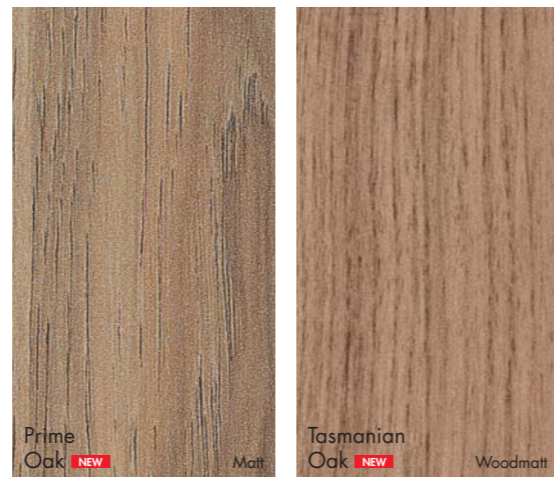
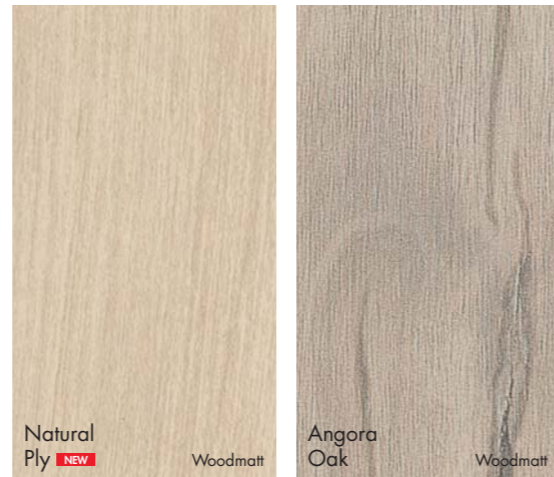

CEILING BRACED system



Full Height Ceiling Braced Floor Mounted
FH-CB-FM



Full Height Ceiling Braced Pedestal Mounted
FH-CB-PM



CEILING FIXED system



Full Height Ceiling Fixed Floor Mounted
FH-CF-FM



Full Height Ceiling Fixed Pedestal Mounted
FH-CF-PM



OVERHEAD BRACED system



Overhead Braced Floor Mounted
OB-FM



Overhead Braced Pedestal Mounted
OB-PM



UNISEX system

polytec recommend specifying a Modesty Edge profile for the Unisex system



Full Height Unisex Ceiling Braced
FH-U-CB



Full Height Unisex Ceiling Fixed
FH-U-CF



PARTITIONING SYSTEMS Standard Hardware range

Black Matt

Satin Chrome



Door hinge

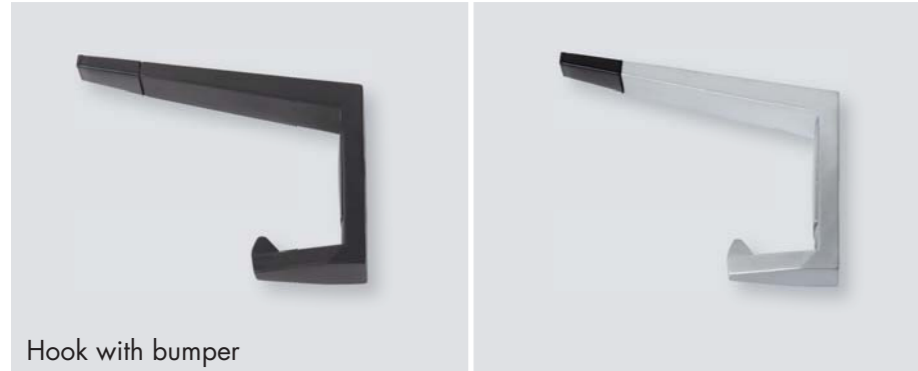

Hook with bumper



Door bumper



Lock indicator



Slide lock



Partitions in 13mm **COMPACT** laminate Black Matt.
Hardware in Black Matt.

PARTITIONING SYSTEMS Standard Hardware range

Black Matt

Satin Chrome



Door handle

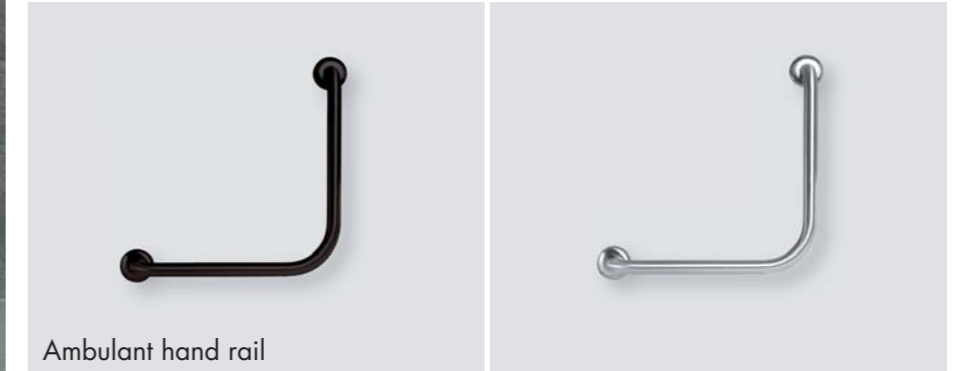

Ambulant hand rail

PARTITIONING SYSTEMS Accessories range



Toilet roll holder

Toilet roll holder

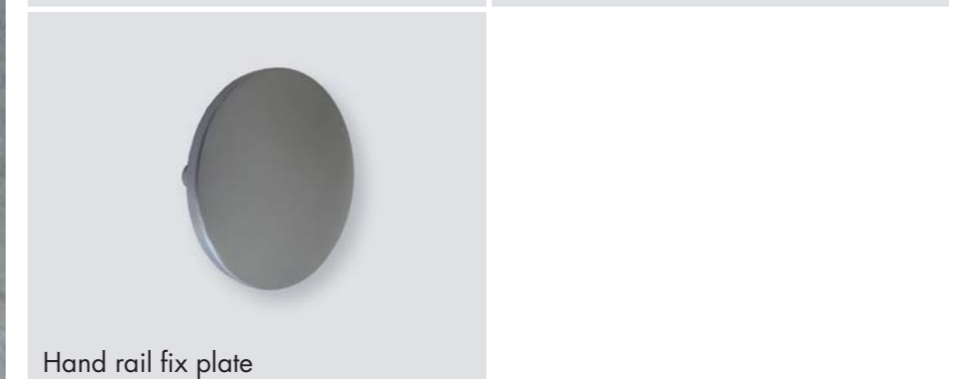

Hand rail fix plate

PARTITIONING SYSTEMS Bench Seating

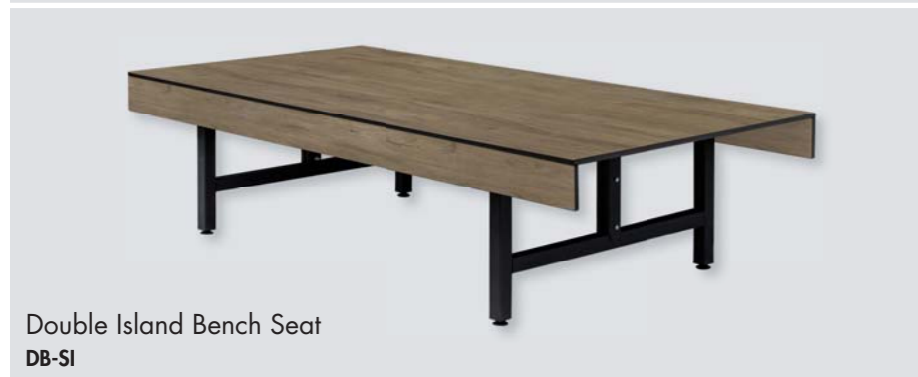

DB-SI and DI-BS-CR are set size items. Refer to technical data for more information.



Urinal division in
13mm **COMPACT** laminate Empire Oak Woodmatt.
Hardware in Black Matt.
Wall panels in
5mm **COMPACT** laminate Calacutta Grey Smooth.

PARTITIONING SYSTEMS Entry Signage

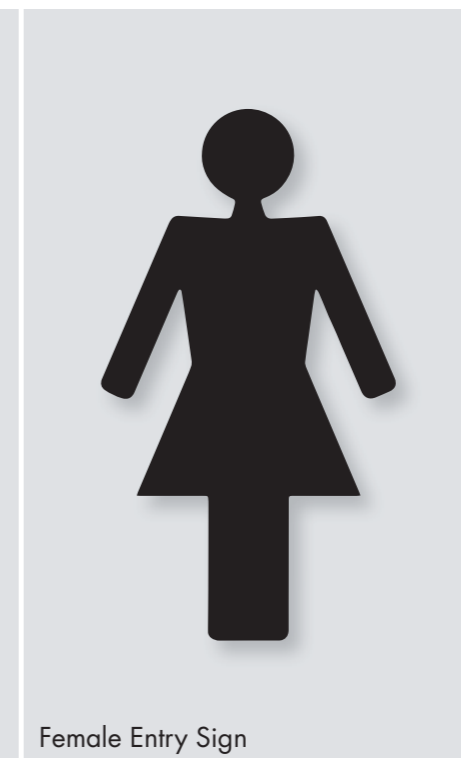

Manufactured from 5mm Compact laminate in Black Matt and measuring 1500mm high x 831mm wide, **polytec's** new Male and Female Entry Signs provide a distinctive wayfinding solution.

PARTITIONING SYSTEMS Urinal Divisions

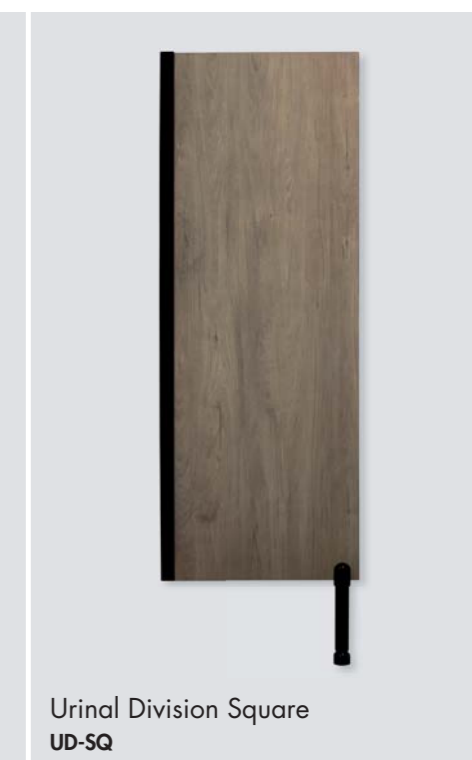
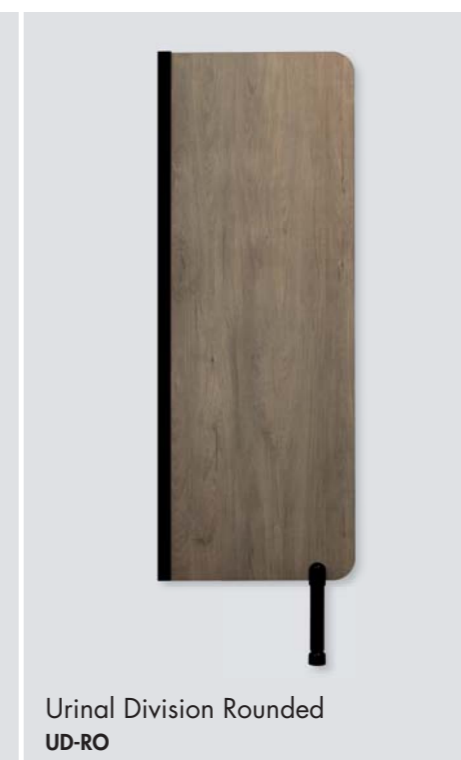



Wall panels in 5mm **COMPACT** laminate Grey Cement Smooth.
 Drop Front Benchtop in 13mm **COMPACT** laminate Catalina Marble Smooth.
 Mirror in **ALUMINIUM** 2/55mm Black Anodised frame with Mirror Glass insert.

Drop Front Benchtop brackets

polytec's newest addition to wet room applications is Drop Front Benchtops. Available in 13mm Compact laminate and 15mm Xenolith, this product is waterproof, antibacterial and durable.

Drop Front Benchtops are manufactured with a 45 degree mitred boxed front and available with boxed ends, sink and tap cutouts. Wall brackets are available as an accessory.

Drop Front Benchtops are fully customisable with grain matching and offer a prefinished solution for wet room applications in commercial and residential projects.

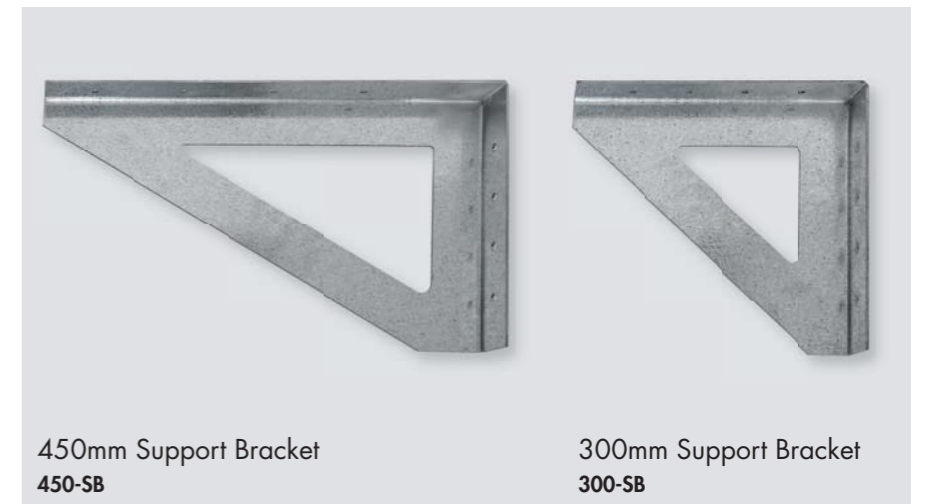

450mm Support Bracket
450-SB

300mm Support Bracket
300-SB

Aluminium frames



2mm Slim Frame design 100% scale

Black Anodised 2/55mm frame with Mirror Glass insert



2mm Slim Frame design 100% scale

Brushed Grey 2/55mm frame with Mirror Glass insert

5mm **COMPACT** laminate Wall Panelling colour range

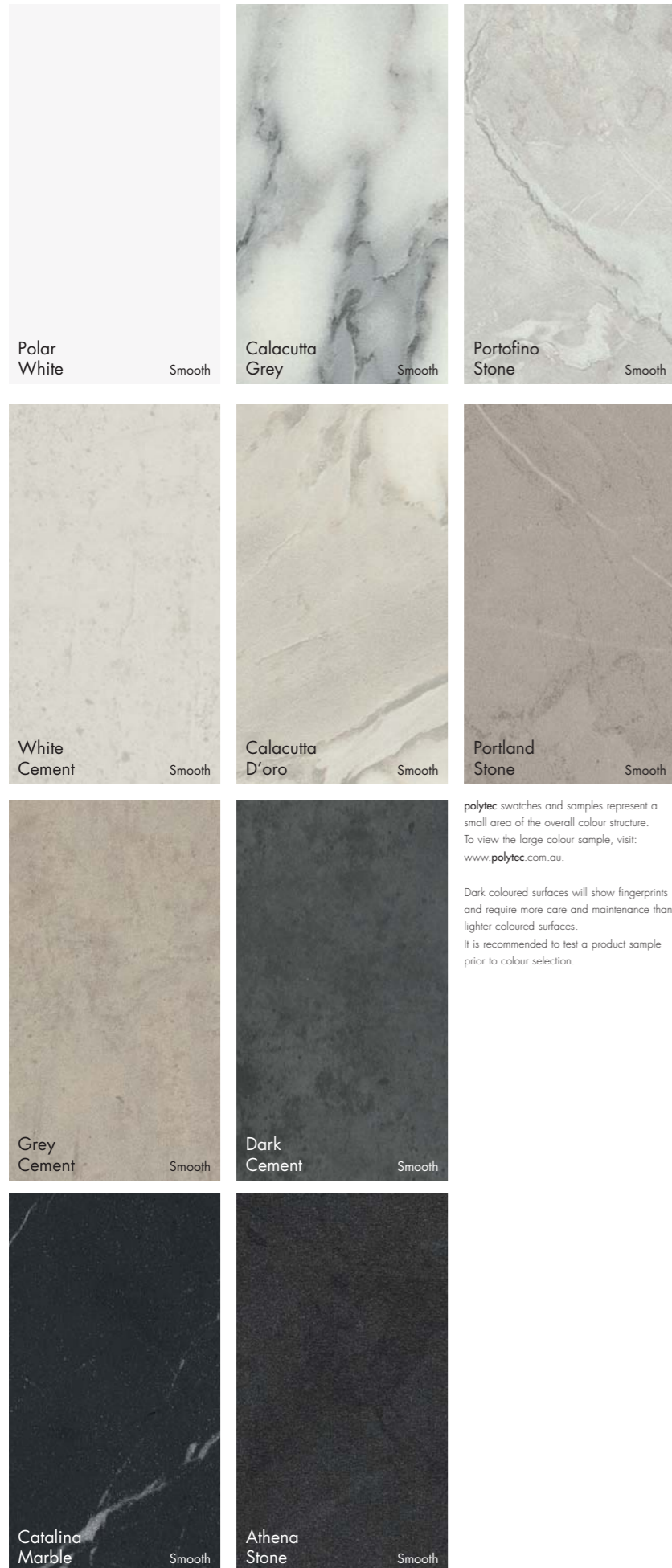

polytec swatches and samples represent a small area of the overall colour structure. To view the large colour sample, visit: www.polytec.com.au.

Dark coloured surfaces will show fingerprints and require more care and maintenance than lighter coloured surfaces. It is recommended to test a product sample prior to colour selection.

Wall panels in 5mm **COMPACT** laminate Athena Stone Smooth.
Partition and seating in 13mm **COMPACT** laminate Grey Cement Smooth.



Wall panels in 5mm **COMPACT** laminate Athena Stone Smooth
and 5mm **COMPACT** laminate Calacutta D'oro Smooth.



ENVIRONMENT & SUSTAINABILITY

polytec is committed to an eco-friendly and sustainable environment. It is an intrinsic part of the way we do business daily. Our decisions are made so that they have minimum negative impact on the environment.

We manage waste responsibly through numerous recycling programs including aluminium and metals, used oils and timber waste is recycled back into packaging and energy. We subscribe to local government environmental initiatives and voluntary audits as well as our own internal Energy and Carbon Management Policy (ECM), which aligns with the Australian Government's Energy Efficiency Opportunities (EEO) program.

Our national portfolio of facilities boasts a total of almost 54,000 solar panels with 17.66 million solar kWh generated, the equivalent of 7,377 trees planted saving close to 12,000 tonne of CO2 emissions. The Oberon facility is now Australia's largest rooftop solar system, with 27,000 panels spread across 8 hectares of rooftop. **polytec** continues to improve on sustainability measures in order to build a circular economy and better future for all.

polytec doors and benchtops are certified Australian Made & Owned.

CARE & MAINTENANCE

The surface of **polytec**'s Compact laminate is made from a stain-resistant melamine based resin. The toughness and high impermeability of this surface means that **polytec**'s Compact laminate should require no more than wiping with a soft cloth, dampened with plain water or a household detergent mix to remove all common household spills.

For more stubborn stains use a mild household cleaning spray. Always ensure you refer to the recommendations provided by the manufacturer of the cleaning product before use.

By following these simple steps you should retain a beautiful surface for many years.

Visit www.polytec.com.au for specific care and cleaning information. Darker colours will show superficial wear and tear more readily than lighter coloured surfaces and require more care and maintenance.

The colours and details shown in this brochure are to the highest standards in printing. However, they should only be used as an indication of actual product colour. To order your free colour sample visit www.polytec.com.au.

polytec swatches and samples represent a small area of the overall colour structure, to view a large colour sample or a full sheet design, visit www.polytec.com.au.

The use of our current samples gives the colour and finish that a customer would expect to receive. Samples are provided for colour and finish selection and **polytec** recommend testing a sample for fingerprint resistance and ease of cleaning. **polytec** does not guarantee exact colour matches across product ranges due to colour variation in each product group.

COMPLEMENTARY RANGES

EVOLUTION range

MELAMINE doors & panels

BENCHTOPS range

ULTRAGLAZE & ULTRAMATT range

COMMERCIAL range

THERMOLAMINATED doors & panels

COMPACT laminate

ALFRESCO & ALUMINIUM framed doors

XENOLITH premium coloured core

WARDROBE range

STECCAWOOD prefinished decorative battens

35mm ARCHITECTURAL doors

COVER IMAGE: Partitions in 13mm **COMPACT** laminate Black Matt.
Hardware in Black Matt.